



ORAL HYGIENE

Varios Combi Pro



Two Maintenance Systems in One

Combining ultrasonic scaling and powder therapy for more effective and comfortable oral hygiene and biofilm control.



Innovative New Design Enables Clinicians to Safely and Efficiently Combine Two Applications

Two Systems in One

NSK has combined ultrasonic treatment and powder therapy into a single professional treatment unit that streamlines procedures and saves time and space.

Automatically Sets Powder Therapy Functions for Supragingival or Subgingival Applications

The clinician simply attaches the relevant powder chamber, and the unit automatically selects the functions for supragingival or subgingival applications. This prevents selection errors.

Independent Unit and Chamber

The detachable chamber and handpiece make it possible to easily switch between supragingival and subgingival applications and make the unit extremely user and maintenance friendly.

Keeps Both Powder Types Separate

Separate chambers, handpieces, and handpiece hoses for supragingival and subgingival procedures eliminate the risk of powder mixing or powder entering the control unit.

Optimizing Manoeuvrability

Automatic Switching from Ultrasonic to Powder Function

An automatic recognition sensor switches from ultrasonic to powder function when a handpiece is picked up from the holder.

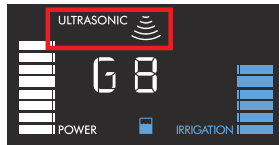

<During Ultrasonic function>

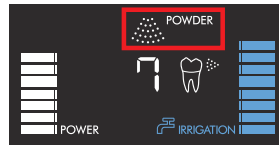

<During Powder function>

Store Previous Settings

The system memory can store such treatment parameters as water volume, air pressure and ultrasonic power settings. Simply pick up the handpiece to switch settings.

*For powder functions, settings change when replacing the chamber.

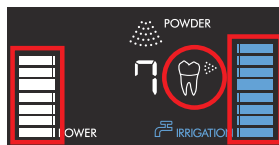

<When using Supragingival>

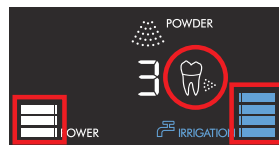

<When using Subgingival>

Auto-cleaning function

Auto-cleaning automatically cleans the handpiece and hose after powder or ultrasonic applications. During the cleaning cycle, the display shows the time remaining to complete the process which takes approximately 45 seconds from start to finish.



Multi-Foot Control

Just using the foot the user can switch ultrasonic or powder modes on or off and change power settings. Combined with a hanger, this offers complete hands-free operations.



ULTRASONIC

A Slim Highly-ergonomic LED Handpiece

The ø9.5 mm slim tip of the Varios LUX handpiece makes it easy to operate throughout the entire oral cavity. The slim handpiece facilitates a smooth approach to difficult to access areas such as the molars. This provides freedom of movement in the oral cavity allowing the tip to be applied at the correct angle. The easy to grip ultra-light handpiece reduces strain on the hands and fingers. With a wide spectrum of close to natural light LED illumination, the view is always bright with high recognition capability.



A wide choice of tips

NSK offers more than 80 tips to optimize treatment in various clinical procedures.

iPiezo engine®

The Unique Ultrasonic AI engine Responds Intelligently

"I'd like to be better at scaling", "I'd like an easier way to remove deposits"

We carefully considered the opinions of clinicians in the development of our unique next-generation AI ultrasonic engine which is at the heart of the NSK ultrasonic series. The actions of the operator are transmitted accurately to the tip, as if it were an extension of the hand. This allows treatment to match tooth surface conditions. The result is faster and gentler treatment for patients and at the same time eco friendly as it operates efficiently with low power consumption.

Feedback Function

The NSK iPiezo engine supplies the appropriate power to the tip depending on the condition of the tooth surface. iPiezo engine provides a stable frequency output without dropping the power, even when removing hard calculus.

Auto Tuning Function

The Auto Tuning Function provides stable frequency to the tip at the selected power range. It allows the operator to feel the power output which ensures the optimum result.

Allows for Steady Scaling

Conventional ultrasonic scalers lose power when moving from soft to hard tartar. The load on the end of the tip is automatically detected by the action of the iPiezo engine allowing for steady scaling without power-loss.

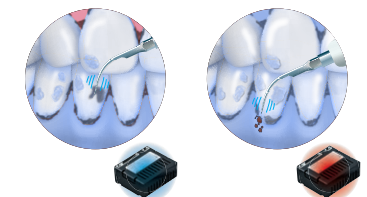

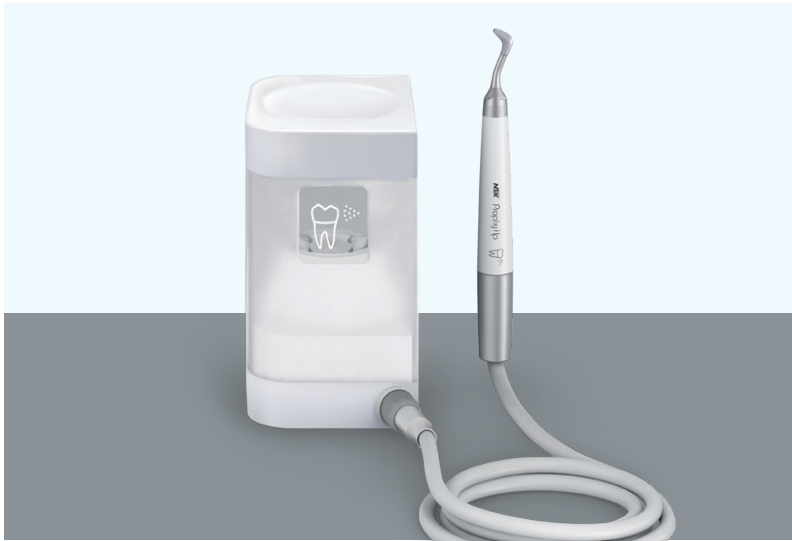

POWDER PROPHY SYSTEM

Cleaning Supragingival Areas Quickly and Efficiently

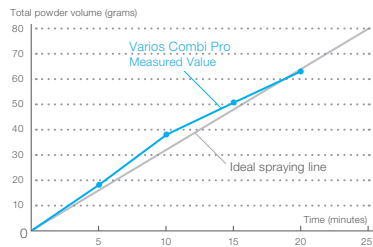

Stable powder spraying

NSK's expertise in fluid analysis techniques, gained through developing turbines, optimize powder flows inside the chamber, streamlining sprays of powder, water and air to significantly shorten chair times.

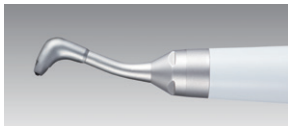

User-friendly handpiece and nozzle

The slim handpiece provides excellent accessibility and manoeuvrability

Powder Solution

NSK powder solution enables non-contact cleaning even in locations where deposits can't be removed as direct contact equipment tips, such as scalars, cannot reach them. ➔ P.112



POWDER PERIO SYSTEM

Gently Cleaning Subgingival Areas

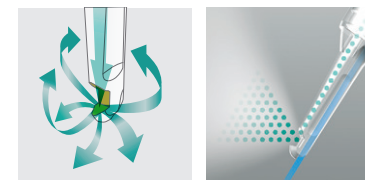

Gentle on soft tissue

Separating powder and water during application prevents periodontal damage. Powder flow is directed in all directions to remove subgingival plaque.

Safe plastic nozzle

Because the nozzle tip is flexible, it can follow tooth contours and is easy to insert into pockets thereby minimizing patient discomfort. The material is semi-transparent to help with visibility. The nozzle tips are sterile and individually packaged so they are ready to use.

Wide range of applications

Applications range from quick biofilm removal to cleaning around dental implants and periodontal pockets. With the nozzle tip removed, clinicians can remove plaque from subgingival pockets of up to 3 mm.

Powder Solution

NSK powder solution enables non-contact cleaning even in locations where deposits can't be removed as direct contact equipment tips, such as scalars, cannot reach them. ➔ P.112

Varios Combi Pro



Varios Combi Pro Basic Set

| MODEL | ORDER CODE |
|-----------------------------------|-----------------|
| Varios Combi Pro Basic Set | Y1002843 |

Contents

- PROPHY-Handpiece with 60° Nozzle
- PROPHY-Hose
- PROPHY-CHAMBER
- FLASH pearl (5 pcs. x 15 g sachets)
- Maintenance kit
- VA2LUX-Handpiece
- VA2LUX-Hose
- 3 Scaling tips
- Sterilization case
- Irrigation bottle (400 mL)
- Foot control

Specifications

- Power Supply : AC 100-240 V 50/60 Hz
- Frequency : 28-32 kHz
- Dimensions : W 225 x D 290 x H 162 (mm) (including chamber)
- Unit weight : 2,6 kg (Except attachment)
- Bottle volume : 400 mL

Optional



| MODEL | ORDER CODE |
|-------|------------|
|-------|------------|

Varios Combi Pro Propy Set **Y1003771**

Contents

- PROPHY-Handpiece
 - PROPHY-Hose
 - PROPHY-CHAMBER
 - 5 x 15 g packs FLASH pearl cleaning powder
- *included in the Varios Combi Pro Basic set



| MODEL | ORDER CODE |
|-------|------------|
|-------|------------|

Varios Combi Pro Perio Set **Y1003042**

Contents

- PERIO-CHAMBER
- PERIO-Hose
- PERIO-Handpiece
- Perio Mate Nozzle tip
- Perio Mate Nozzle tip remover
- Perio Mate powder



| MODEL | BESTELLCODE |
|-------|-------------|
|-------|-------------|

iCart Propy **S9095**

Contents

- Dimensions : W 450 x D 380 x H 660 mm
- Weight : 21 kg

Prophy-Mate neo



Improved Polishing Power

With NSK original twin nozzles, greater polishing power is realized. With powerful jet, cleaning time is greatly shortened thus reduces treatment time.



Easy Detachable Nozzles with 60° and 80°

Selectable 60° and 80° nozzles maximize the cleaning ability. 60° nozzle works especially well for molar area and occluding surface and 80° nozzle for anterior tooth.

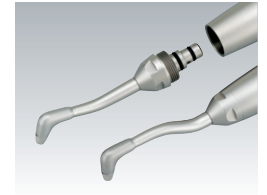

Smooth, Easy 360° Swivel

Twin joints rotate smoothly 360 degrees for easy operability, responding flexibly to minute fingertip movements with effortless adjustment of the nozzle angle.

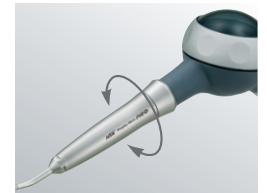

Simple One-touch Connection

The Prophy-Mate neo is designed for a one-touch attachment to NSK couplings and other major coupling brands. The handpiece also can be attached to the powder case with one-touch operation.

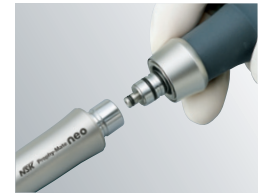

Product Maintenance

The user can easily disassemble the nozzle, handpiece and powder case. Powder clogging is unlikely when handled and maintained correctly but is easy to manage by following the maintenance guidelines and the relevant accessories included with the product.

Powder Solution

NSK powder solution enables non-contact cleaning even in locations where deposits can't be removed as direct contact equipment tips, such as scalers, cannot reach them.

➔ P.112

Prophy-Mate neo

Supragingival Powder Therapy device

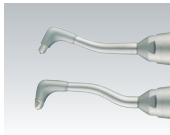

60° and 80° nozzles



Prophy-Mate neo Complete System

| | MODEL | ORDER CODE |
|--|-------------------|----------------|
| NSK Coupling | PMNG-PTL-P | Y135029 |
| KaVo® Coupling | PMNG-KV-P | Y135030 |
| Sirona® Coupling | PMNG-SR-P | Y135031 |
| W&H® Roto Quick | PMNG-WH-P | Y135032 |
| Bien-Air® Unifix® | PMNG-BA-P | Y135033 |
| Midwest 4 hole (Direct-connect / Screw-on Type) | PMNG-M4-P | Y135034 |
| Borden 2 hole (Direct-connect / Screw-on Type) | PMNG-B2-P | Y135035 |

■ No light during use (when using optic coupling).

Contents

- Handpiece with 60° nozzle head
- Powder case
- Replacement nozzle head 80°
- 5 pcs. x 15 g sachets of FLASH pearl cleaning powder
- Maintenance kit



Perio-Mate

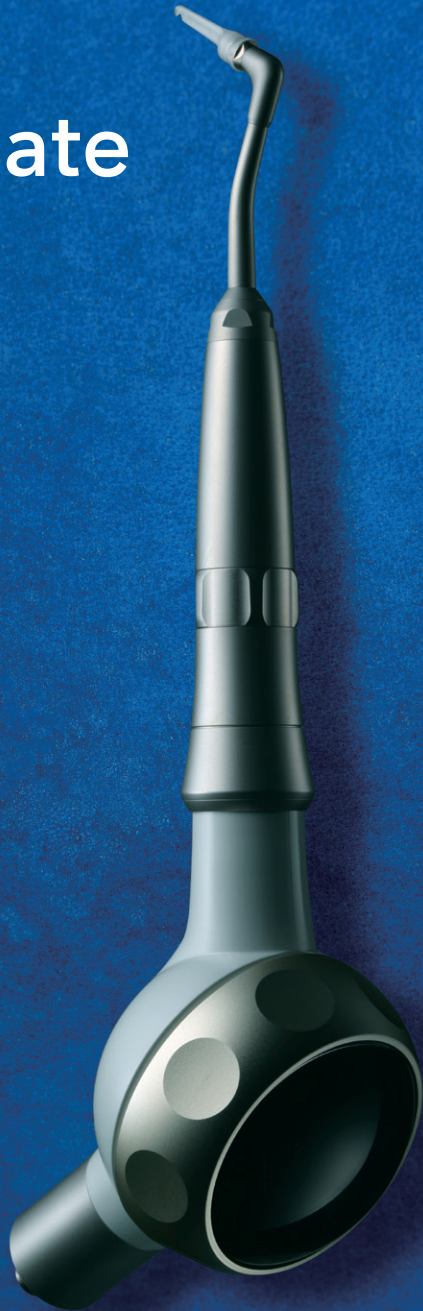

Extensive range of applications ranging from supragingival to subgingival use

By removing the Perio-Mate Nozzle Tip, the subgingival area up to 3 mm from the gum line that requires the most frequent maintenance can be treated.



Optimize Using Powder Flow Analysis

Turbine development technology uses accumulated fluid analysis which allows 'spraying' that takes into account the powder flow in the pocket. It is not mono-directional, rather the flow is even and all-directional, minimising soft-tissue damage and subgingival plaque and biofilm can be removed efficiently. With respect to potential damage, powder (air) and water are separately discharged onto periodontal tissue.



Slim Nozzle Facilitates Operation in The Narrow Confines of The Oral Cavity

The long, narrow nozzle shape is designed to allow easy access to areas that require inserting the handpiece at an angle, such as between molars.

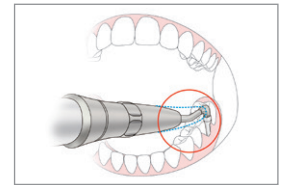

Smooth 360-degree Rotation for Safe and Accurate Operation

The handpiece can easily be rotated using the fingertips even while performing complex operations. The nozzle tip allows easy access to difficult to reach areas, and does not adversely affect neighbouring teeth and contours.

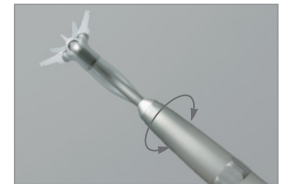

Powder Flow Volume Adjustment

The Perio-Mate's convenient Powder Control Ring makes fine-tuning powder flow simple and intuitive with quick fingertip adjustments. In addition to easily controlling and stopping the flow of powder in this way, you can cleanse the treatment area from biofilm uninterruptedly.



Product Maintenance

The user can easily disassemble the nozzle, handpiece and powder case. Powder clogging is unlikely when handled and maintained correctly but is easy to manage by following the maintenance guidelines and the relevant accessories included with the product.

Powder Solution

NSK powder solution enables non-contact cleaning even in locations where deposits can't be removed as direct contact equipment tips, such as scalers, cannot reach them.

➔ P.112

Perio-Mate

Subgingival Powder Therapy device
(biofilm eraser)



Perio-Mate Complete System

| | MODEL | ORDER CODE |
|--|------------------|-----------------|
| NSK Coupling | PER-PTL-P | Y1002654 |
| KaVo® Coupling | PER-KV-P | Y1002655 |
| Sirona® Coupling | PER-SR-P | Y1002656 |
| W&H® Roto Quick | PER-WH-P | Y1002657 |
| Bien-Air® Unifix® | PER-BA-P | Y1002658 |
| Midwest 4 hole (Direct-connect / Screw-on Type) | PER-M4-P | Y1002659 |
| Borden 2 hole (Direct-connect / Screw-on Type) | PER-B2-P | Y1002660 |

■ No light during use (when using optic coupling).

Contents

- Handpiece • Powder case • Nozzle tip (40 pcs) • Maintenance kit
- Perio-Mate Powder 160 g x 1

Perio Mate Nozzle Tip

Subgingival Air polishing device for removing biofilm.

Flexible Plastic Nozzle Tip Design Ensures Accessibility and is Gentle to The Pocket

The slim nozzle tip possesses just the right degree of flexibility to pass smoothly over tooth surfaces, and can be easily inserted into tight pockets and the root surfaces of adjacent teeth without causing the patient discomfort.



| MODEL | ORDER CODE |
|------------------------------|-----------------|
| Perio Mate Nozzle Tip | Y1002741 |

Contents

- 40 pcs per pack



Powder Solution

For long lasting, beautiful and healthy teeth



| Solution | At | For | With |
|--|---|---|--|
| <p>Prophy-Mate neo</p>  <p>Removal of stains & plaque Removal of biofilm</p> |  <p>Supragingival</p> | <p>Natural tooth</p> <p>Prosthetic tooth (Only SOFT pearl*)</p> |  <p>FLASH pearl</p>  <p>SOFT pearl</p> |
| <p>Varios Combi Pro</p>  <p>Removal of plaque Removal of biofilm</p> |  <p>Supragingival (Gingival margin)</p> | <p>Natural tooth</p> |  <p>Perio Mate Powder</p> |
| <p>Perio-Mate</p>  |  <p>Subgingival</p> | <p>Prosthetic tooth</p> | |

*with some exceptions.

FLASH pearl

Features

- Supragingival application
- Principal ingredient is calcium carbonate. Non-flavoured.
- For all grades of stainings and discolorations; with special efficiency in strong stainings
- Sodium-free, so no unpleasant salty taste and ideal for patients on sodium-restricted diets
- Spherical granules are gentle on tooth surfaces
- Average particle diameter is 54 µm

Usage

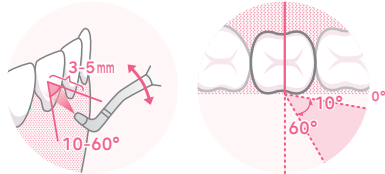

For Supragingival



| MODEL | ORDER CODE |
|-----------------------------|----------------|
| FLASH pearl (Bottle) | Y900698 |

- 4 bottles packed in a box
- Each bottle contains 300 g

Perio Mate Powder

Features

- Subgingival application
- Principal ingredient is glycine, an amino acid present in proteins
- Highly water soluble to prevent subgingival retention
- Lower Mohs hardness than dentin
*Glycine ranks 2 on the Mohs hardness scale, while dentin is 2 to 2.5
- Average powder particle diameter is 25 µm

Usage

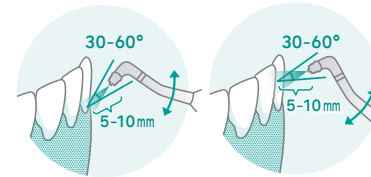

For Supragingival



| MODEL | ORDER CODE |
|--------------------------|----------------|
| Perio Mate Powder | Y900938 |

- 2 bottles packed in a box
- Each bottle contains 160 g

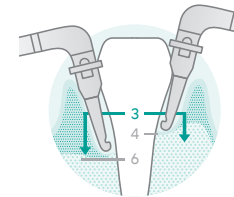

For Subgingival

SOFT pearl

Features

- Supragingival application
- Principal ingredient is glycine, an amino acid present in proteins
- For all grades of stainings and discolorations; with special efficiency in slight to medium stainings
- For heavy users using an amalgam separator or wet suction
- Can be used for primary teeth („milk teeth“)
- Average powder particle diameter 65 µm

Usage

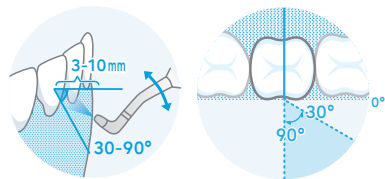

For Supragingival



| MODEL | ORDER CODE |
|-------------------|-----------------|
| SOFT pearl | Y1500721 |

- 4 bottles packed in a box
- Each bottle contains 250 g



Varios 970

The Smart Compact Design Provides High-performance

Large LED Display

The large LED display has a 10 stage numeric power display and bar graph to show the irrigation volume. Beyond this, intuitive layout of operating keys minimize user errors. Power adjustment and function selection can be performed easily and reliably.



Large Solution Bottles

The two bottles can be placed and removed easily and can be used for any type of irrigation to complement treatment. Large 400 mL bottles deliver ample irrigation capacity and reduced chair time. Repeated tests of our components and material studies ensure high durability even when used extensively with antiseptic irrigation solutions.



Improved Durability Against Antiseptic Solutions

The introduction of the resin based water pipe of the bottle, pump and handpiece, assures dramatically improved durability as it substantially reduces the corrosion and rust caused by the residuum of antiseptic solutions.



Auto Cleaning Mode

The Auto Cleaning Mode flushes the tubing, handpiece and tips at the push of a button when required. The two channels can be flushed independently.



Varios 970 Complete Sets

| Optic | MODEL | ORDER CODE |
|-------|------------------|-----------------|
| ● | VA970 LUX | Y1004161 |
| — | VA970 | Y1004160 |

Contents

- Control unit • Handpiece • Handpiece cord • 3 Scaling tips (G4, G8, G16) • Foot control (FC-70)
- 2 x Irrigation bottles • 3 x Tip wrench with torque limiter • AC power cord • Sterilization case

Specifications

- | | |
|------------------------------------|--|
| • Power Supply : AC 230 V 50/60 Hz | • Dimensions : W 160 x D 270 x H 190 (mm) (Including Bottle) |
| • Frequency : 28-32 kHz | • Unit weight : 2.1 kg (Except attachment) |
| • Max. output : 11 W (G mode) | • Bottle volume : 400 mL (x 2 bottles) |

Varios 570

Compact and Versatile

Varios 570 offers three power modes selectable to the tip connected to the handpiece; "G"(general), "E"(endo) and "P"(perio). Power level can be fine-turned within the range of given power mode. In particular, P mode offers minimal yet steady power for more effective periodontic treatment.

Advantages

- Powered by iPiezo engine
- Compact and appropriate-sized body design
- User friendly and intuitive operation control panel



Varios 570 Complete Set

| Optic | MODEL | ORDER CODE |
|-------|-----------|------------|
| ● | VA570 LUX | Y1001273 |

Contents

- Control unit with handpiece cord • AC adaptor • Handpiece • Water filter set
- Water supply connector • Foot control (FC-70) • 3 Scaling tips • Tip wrench with torque limiter

Specifications

- Power Supply : AC 100-240 V 50/60 Hz
- Frequency : 28-32 kHz
- Max. output : 11 W (G mode)
- Dimensions : W 160 x D 135 x H 65 (mm)
- Unit weight : 0.43 kg

Varios 370

Compact Multipurpose Control Unit at Your Fingertips

Varios 370 has been especially developed to offer a compact, portable control unit allowing easy installation into any dental unit. It is simple to operate and suitable for a variety of clinical procedures.

Advantages

- Powered by iPiezo engine
- Potable ultra compact body
- Simple and intuitive operation control panel



Varios 370 Units Installation Examples



On the dental console arm with Stand (optional).

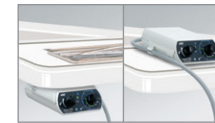

On/Under the dental bracket table with Control Unit Holder



Varios 370 Complete Set

| Optic | MODEL | ORDER CODE |
|-------|-------|------------|
| — | VA370 | Y1001340 |

Contents

- Control unit with handpiece cord • Control unit holder • AC adaptor • Handpiece • Handpiece holder
- Water filter set • Foot control (FC-71) • 3 Scaling tips • Tip wrench with torque limiter

Specifications

- Power Supply : AC 100-240 V 50/60 Hz
- Frequency : 28-32 kHz
- Max. output : 11 W (G mode)
- Dimensions : W 80 x D 115 x H 32 (mm) (without knob and cord)
- Unit weight : 0.43 kg (without attachment)

Varios 170

Integrated Multi Function Ultrasonic Scaler

Varios 170 is the world's smallest built-in optic control module.

It features the NSK iPiezo engine which ensures stable power output all the times.

The slimmer and extremely lightweight handpiece with twin LED is easily added to the existing handpiece delivery unit and is controlled via the existing foot control.

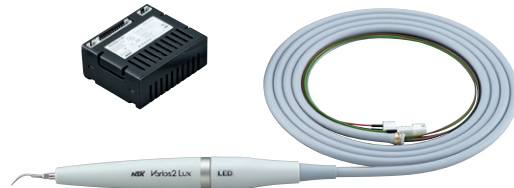

Sterilization Case

The handpiece, tips and tip wrenches can be sterilized together for your convenience.



Varios 170 Complete Sets



| Optic | MODEL | ORDER CODE |
|-------|-------------------|-----------------|
| ● | VA170LUXS8 | Y1004145 |
| — | VA170S8 | Y1004144 |

Contents

- Built in module
- Handpiece
- Handpiece cord
- 3 Scaling tips (G4, G8, G16)
- 3 x Tip replacement wrench with torque limiter

Specifications

- Power Supply : AC 24 V ±10%
- Frequency : 28-32 kHz
- Max. output : 11 W
- Dimensions : W 63 x D 54 x H 26 (mm)
- Module weight : 59 g

Ultrasonic Scaler Tips

NSK Offers a Wide Choice of Varios Ultrasonic Scaler Tips for Clinical Applications.

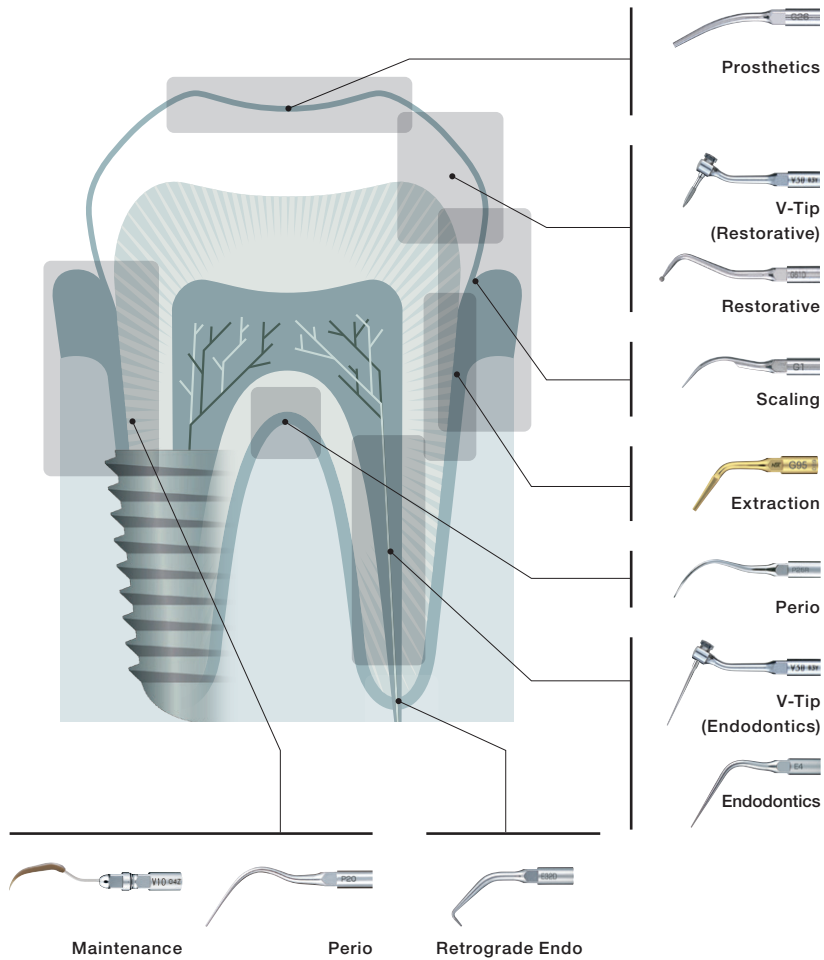



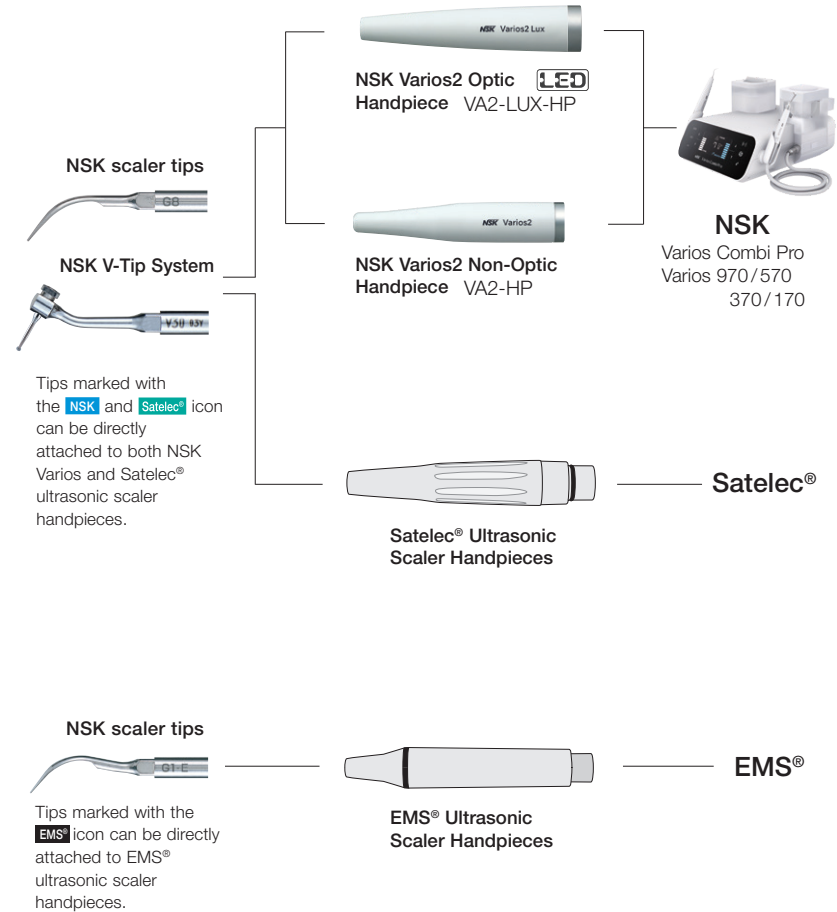















































NSK tips fit Varios2 ultrasonic scaler handpieces as well as Satelec® ultrasonic scaler handpieces. NSK make a number of tips which will fit on EMS® ultrasonic scaler handpieces. The following is a guide to illustrate all NSK Varios tips, their applications and connectivity.



Scaling

Cross Section Diagram

| MODEL | ORDER CODE | |
|--|----------------|------------|
|      G1 | Z217101 | |
|  G1-E | Z291101 | |
| <th>MODEL</th> <th>ORDER CODE</th> | MODEL | ORDER CODE |
|      G2 | Z217102 | |
|  G2-E | Z291102 | |
| <th>MODEL</th> <th>ORDER CODE</th> | MODEL | ORDER CODE |
|      G3 | Z217103 | |
|  G3-E | Z291103 | |
| <th>MODEL</th> <th>ORDER CODE</th> | MODEL | ORDER CODE |
|      G4 | Z217104 | |
|  G4-E | Z291104 | |
| <th>MODEL</th> <th>ORDER CODE</th> | MODEL | ORDER CODE |
|      G5 | Z217105 | |
| <th>MODEL</th> <th>ORDER CODE</th> | MODEL | ORDER CODE |
|      G6 | Z217106 | |
|  G6-E | Z291106 | |
| <th>MODEL</th> <th>ORDER CODE</th> | MODEL | ORDER CODE |
|      G8 | Z217108 | |
| <th>MODEL</th> <th>ORDER CODE</th> | MODEL | ORDER CODE |
|      G9 | Z217109 | |
| <th>MODEL</th> <th>ORDER CODE</th> | MODEL | ORDER CODE |
|      G11 | Z217411 | |





















Scaling

Cross Section Diagram

| MODEL | ORDER CODE | |
|--|----------------|------------|
|      G12 | Z217412 | |
| <th>MODEL</th> <th>ORDER CODE</th> | MODEL | ORDER CODE |
|      G13 | Z217413 | |
| <th>MODEL</th> <th>ORDER CODE</th> | MODEL | ORDER CODE |
|      G16 | Z217120 | |



Perio (Root Planing)

Cross Section Diagram

| MODEL | ORDER CODE | |
|--|----------------|------------|
|      P1 | Z217404 | |
| <th>MODEL</th> <th>ORDER CODE</th> | MODEL | ORDER CODE |
|      P1D | Z217405 | |
| • Diamond coated | | |
| <th>MODEL</th> <th>ORDER CODE</th> | MODEL | ORDER CODE |
|      P2D | Z217402 | |
| • Diamond coated • Right curved type | | |
| <th>MODEL</th> <th>ORDER CODE</th> | MODEL | ORDER CODE |
|      P3D | Z217403 | |
| • Diamond coated • Left curved type | | |

Perio (Root Planing)



Cross Section Diagram

| MODEL | ORDER CODE |
|---|----------------|
| NSK Satelec® P10 | Z217410 |

- Sharp edge



Cross Section Diagram

| MODEL | ORDER CODE |
|--|----------------|
| NSK Satelec® P11R | Z217408 |

- Sharp edge • Right curved type



Cross Section Diagram

| MODEL | ORDER CODE |
|--|----------------|
| NSK Satelec® P11L | Z217409 |





- Sharp edge • Left curved type

Cross Section Diagram

| MODEL | ORDER CODE |
|---|----------------|
| NSK Satelec® P20 | Z217420 |
| EMS® P20-E | Z291420 |



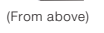

Cross Section Diagram

| MODEL | ORDER CODE |
|--|----------------|
| NSK Satelec® P21R | Z217422 |
| EMS® P21R-E | Z291422 |

- Right curved type

Cross Section Diagram

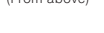
| MODEL | ORDER CODE |
|--|----------------|
| NSK Satelec® P21L | Z217421 |
| EMS® P21L-E | Z291421 |

- Left curved type

Perio (Root Planing)

Cross Section Diagram





| MODEL | ORDER CODE |
|--|----------------|
| NSK Satelec® P25R | Z217424 |
| EMS® P25R-E | Z291424 |

- Right curved type

Cross Section Diagram





| MODEL | ORDER CODE |
|--|----------------|
| NSK Satelec® P25L | Z217425 |
| EMS® P25L-E | Z291425 |

- Left curved type

Cross Section Diagram





| MODEL | ORDER CODE |
|--|----------------|
| NSK Satelec® P26R | Z217426 |

- Right curved type

Cross Section Diagram





| MODEL | ORDER CODE |
|--|----------------|
| NSK Satelec® P26L | Z217427 |

- Left curved type

Perio (Irrigation and Cleaning)

Cross Section Diagram





| MODEL | ORDER CODE |
|---|----------------|
| NSK Satelec® P40 | Z217550 |

- Tip diameter ø0.6 mm

Cross Section Diagram





| MODEL | ORDER CODE |
|---|----------------|
| NSK Satelec® P41 | Z217555 |

- Tip diameter ø0.8 mm

**Maintenance (V-Tip)
Perio-Control**



| MODEL | ORDER CODE |
|------------|----------------|
| V10 | Z217041 |

- Includes E-Tip replacement wrench
- Plastic Tip is not included

For the maintenance of prostheses and implants. Produced from special material to allow safe debridement without causing damage to metals and implants.

Cross Section Diagram



| MODEL | ORDER CODE |
|--------------|----------------|
| V-P10 | Y900184 |

- Pack of 3
- V10 holder is not included

V-P12 is a longer version of the popular V-P10 tip. It serves a wide range of applications, including the maintenance of implants and other prosthetic devices. Its shape offers easy access to all treatment areas.



| MODEL | ORDER CODE |
|--------------|-----------------|
| V-P12 | Y1002167 |

- Pack of 3
- V10 holder is not included



V-P10



V-P12



V-P11R

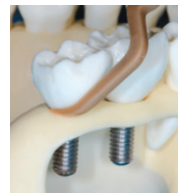

V-P26R

Maintenance (V-Tip)

V-P11R/L left and right are double bent tips. This tip is extra long to easily access difficult to reach areas and to avoid interference with neighbouring teeth or contours. Its shape was designed to best fit different tooth morphologies, making this a versatile tip for a wide range of uses from anterior teeth to premolars.

Cross Section Diagram



| MODEL | ORDER CODE |
|---------------|-----------------|
| V-P11R | Y1002165 |

- Right curved type • Pack of 3
- V10 holder is not included



| MODEL | ORDER CODE |
|---------------|-----------------|
| V-P11L | Y1002166 |

- Left curved type • Pack of 3
- V10 holder is not included

V-P26R/L is a double-bent tips. The wide angles offer access to areas that cannot be reached with V-P11R/L tips or other conventional instruments. These tips are ideally suited to access the distal surfaces of molars and corner areas as, the end of the tip fits tooth morphology very closely.



| MODEL | ORDER CODE |
|---------------|-----------------|
| V-P26R | Y1002168 |

- Right curved type • Pack of 3
- V10 holder is not included



| MODEL | ORDER CODE |
|---------------|-----------------|
| V-P26L | Y1002169 |

- Left curved type • Pack of 3
- V10 holder is not included

Endodontics

| | | | | | |
|-----------------------------|---|--|----------------|------------|------------|
| Cross Section Diagram | | | | MODEL | ORDER CODE |
| | | E4 | Z217428 | | |
| | | <ul style="list-style-type: none"> • For root canal cleaning | | | |
| | | | | MODEL | ORDER CODE |
| | | E4D | Z217528 | | |
| | | <ul style="list-style-type: none"> • Diamond coated • For root canal enlargement | | | |
| | | | MODEL | ORDER CODE | |
| | E5 | Z217305 | | | |
| | <ul style="list-style-type: none"> • Water not required • For lateral condensation | | | | |
| | | | MODEL | ORDER CODE | |
| | E6 | Z217306 | | | |
| | <ul style="list-style-type: none"> • Water not required • For lateral condensation | | | | |
| | | | MODEL | ORDER CODE | |
| | E7 | Z217307 | | | |
| | <ul style="list-style-type: none"> • Water not required • For removal of filling and foreign material | | | | |
| | | | MODEL | ORDER CODE | |
| | E7D | Z217317 | | | |
| | <ul style="list-style-type: none"> • Diamond coated • For enlargement of root canal wall | | | | |

Endodontics

| | | | | | |
|-----------------------------|--|---|----------------|------------|------------|
| Cross Section Diagram | | | | MODEL | ORDER CODE |
| | | E8 | Z217308 | | |
| | | <ul style="list-style-type: none"> • Water not required • For removal of filling and foreign material | | | |
| | | | | MODEL | ORDER CODE |
| | | E8D | Z217318 | | |
| | | <ul style="list-style-type: none"> • Diamond coated • For enlargement of root canal wall | | | |
| | | | MODEL | ORDER CODE | |
| | E15D | Z217319 | | | |
| | <ul style="list-style-type: none"> • Diamond coated • For locating root canals and removal of calcifications | | | | |

* Cross section diagram is the image of a point 1 mm from the end. The illustrated tip diagram is three times bigger than the actual size.

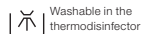

* For tips E5, E6, E7, E7D, E8, and E8D, please use the attached E Tip Replacement Wrench.

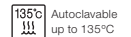
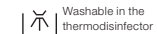

Endodontics

120° Angle Holder for U files



| MODEL | ORDER CODE |
|------------|----------------|
| E11 | Z217031 |

- For U files (ø0.8 mm)
- For root canal cleaning
- For anterior teeth • File is optional

95° Angle Holder for U files



| MODEL | ORDER CODE |
|------------|----------------|
| E12 | Z217032 |

- For U files (ø0.8 mm)
- For root canal cleaning
- For posterior teeth
- File is optional



| MODEL | ORDER CODE |
|-------|------------|
|-------|------------|

U files 33 mm / #15 Y900062

- ISO 15 • Pack of 6

| MODEL | ORDER CODE |
|-------|------------|
|-------|------------|

U files 33 mm / #20 Y900063

- ISO 20 • Pack of 6

| MODEL | ORDER CODE |
|-------|------------|
|-------|------------|

U files 33 mm / #25 Y900064

- ISO 25 • Pack of 6

| MODEL | ORDER CODE |
|-------|------------|
|-------|------------|

U files 33 mm / #30 Y900065

- ISO 30 • Pack of 6

| MODEL | ORDER CODE |
|-------|------------|
|-------|------------|

U files 33 mm / #35 Y900066

- ISO 35 • Pack of 6

Each pack of E11, E12 or V30 includes 1 x E Tip replacement wrench.
Replacement wrench is not included when ordering other tips.
Please order the replacement wrench separately in this instance.

Always refer to this reference chart to ensure correct and accurate proper file length to avoid file breakage.

| | #15 | #20 | #25 | #30 | #35 |
|-----|-------|---------|---------|---------|-------|
| E11 | 22 mm | 24.5 mm | 22 mm | 22 mm | 22 mm |
| E12 | 22 mm | 24.5 mm | 24.5 mm | 24.5 mm | 22 mm |

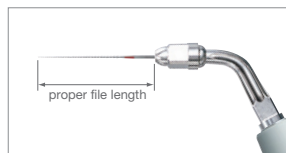

Retrograde Endo

Cross Section Diagram

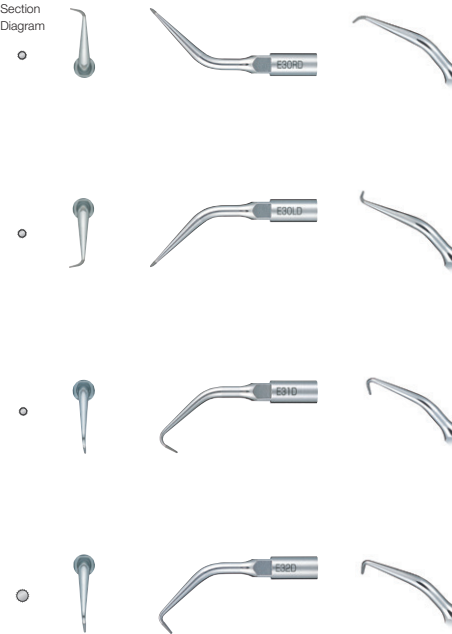

| MODEL | ORDER CODE |
|--------------|----------------|
| E30RD | Z217212 |

- Diamond coated
- For posterior teeth (right angled)

| MODEL | ORDER CODE |
|--------------|----------------|
| E30LD | Z217213 |

- Diamond coated
- For posterior teeth (left angled)

| MODEL | ORDER CODE |
|-------------|----------------|
| E31D | Z217210 |

- Diamond coated
- For anterior and posterior teeth (70°)

| MODEL | ORDER CODE |
|-------------|----------------|
| E32D | Z217211 |

- Diamond coated
- For anterior teeth (90°)

* Cross section diagram is the image of a point 1 mm from the end. The illustrated tip diagram is three times bigger than the actual size.

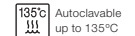
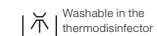

Extraction

Because the tip and the bilateral edges of the G95 tip are sharp it can be inserted without applying excessive force. Furthermore, because the abrasion of the periodontal ligaments using the tip creates a space between the tooth root surface and alveolar bone, tooth extraction can be conducted without injuring the bone around the root.

Features

- Access to a surgical site is improved by thinning the tip apex shape and sharpening both edge flanks.
- Adhesion areas of periodontal membrane can be removed smoothly.
- Tooth removal can be performed smoothly so that patient discomfort can be reduced.
- Approaches from angles hard to reach with hand instruments are also possible.

**Root extraction
(upper left No. 2 tooth removal)**

Tooth extraction is possible without excessively cutting the alveolar bone around the remaining root, retaining the morphology of the alveolar bone.

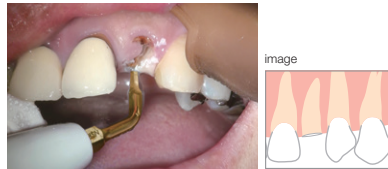

**Impacted tooth
(lower left No. 8 tooth removal)**

The use of the tip prior to extraction will mobilise the tooth and make extraction easier.

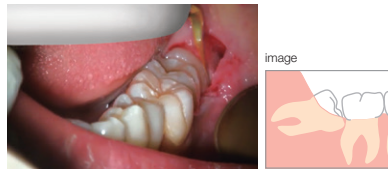

Be careful not to apply excessive force, as in cases of using elevators.
Nishikawa-guchi dental clinic

| MODEL | ORDER CODE |
|----------------|----------------|
| NSK G95 | Z217705 |

• TiN coating • 0.7 mm thick
• A double edge, which is sharp in three directions

Restorative (For Minimal Intervention)

| MODEL | ORDER CODE |
|--------------------------|----------------|
| NSK Satelec® G61D | Z217601 |
| • Diamond coated | |
| MODEL | ORDER CODE |
| NSK Satelec® G62D | Z217602 |
| • Diamond coated | |
| MODEL | ORDER CODE |
| NSK Satelec® G65D | Z217605 |
| • Diamond coated | |
| MODEL | ORDER CODE |
| NSK Satelec® G66D | Z217606 |
| • Diamond coated | |
| MODEL | ORDER CODE |
| NSK Satelec® G67D | Z217607 |
| • Diamond coated | |
| MODEL | ORDER CODE |
| NSK Satelec® G68D | Z217608 |
| • Diamond coated | |

* Cross section diagram is the image of a point 1 mm from the end. The illustrated tip diagram is three times bigger than the actual size.

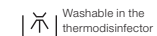

Condensation



NSK
Satelec

| MODEL | ORDER CODE |
|------------|----------------|
| G21 | Z217010 |

- Water not required
- For anterior teeth
- 3 caps supplied



| MODEL | ORDER CODE |
|----------------|----------------|
| Tip Cap | Y140751 |

- Autoclavable
- For G21 / G22 (Pack of 10)

Varios V-TIP System



NSK Varios V-Tip holder system is innovative, multi-functional and economical. The V-Tip holder is a separate component to the actual cutting tips and can be easily and inexpensively replaced. NSK V-Tip holder system offers the flexibility and expandability to meet the wide requirements for multi-purpose clinical applications.

Restorative

P.142-143

- For Minimal Intervention
- For Finishing / Trimming / Polishing
- For Caries Removal



Endodontics

P.141

- For Root Canal Cleaning
- For Root Canal Enlargement

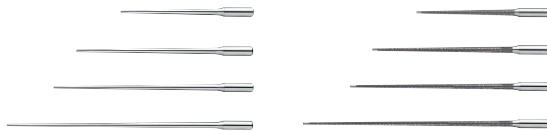

- Ni-Ti Irrigation



Maintenance

P.130-131

- For Prostheses or Implant Maintenance
Perio-Control



V30
120° Angle type



V10
Straight

Endodontics V-Tip



NSK
Satelec

- For root canal cleaning 17 mm • Pack of 3

- For root canal cleaning 23 mm • Pack of 3

- For root canal cleaning 26 mm • Pack of 3

- For root canal cleaning 32 mm • Pack of 3

- Diamond coated
- For root canal enlargement 17 mm • Pack of 3

- Diamond coated
- For root canal enlargement 23 mm • Pack of 3

- Diamond coated
- For root canal enlargement 26 mm • Pack of 3

- Diamond coated
- For root canal enlargement 32 mm • Pack of 3

- Ni-Ti Irrigation 17 mm • Pack of 3

- Ni-Ti Irrigation 21 mm • Pack of 3



* In order to reduce the incidence of ledge formation, there is no diamond coating on the end of the tip. (1.0 mm)

| MODEL | ORDER CODE |
|-------|------------|
|-------|------------|

| | |
|------------|----------------|
| V30 | Z217030 |
|------------|----------------|

- Tip is optional

| MODEL | ORDER CODE |
|-------|------------|
|-------|------------|

| | |
|--------------|----------------|
| V-S50 | Y900169 |
|--------------|----------------|

| MODEL | ORDER CODE |
|-------|------------|
|-------|------------|

| | |
|--------------|----------------|
| V-S51 | Y900170 |
|--------------|----------------|

| MODEL | ORDER CODE |
|-------|------------|
|-------|------------|

| | |
|--------------|----------------|
| V-S52 | Y900171 |
|--------------|----------------|

| MODEL | ORDER CODE |
|-------|------------|
|-------|------------|

| | |
|--------------|----------------|
| V-S53 | Y900172 |
|--------------|----------------|

| MODEL | ORDER CODE |
|-------|------------|
|-------|------------|

| | |
|---------------|----------------|
| V-S50D | Y900173 |
|---------------|----------------|

| MODEL | ORDER CODE |
|-------|------------|
|-------|------------|

| | |
|---------------|----------------|
| V-S51D | Y900174 |
|---------------|----------------|

| MODEL | ORDER CODE |
|-------|------------|
|-------|------------|

| | |
|---------------|----------------|
| V-S52D | Y900175 |
|---------------|----------------|

| MODEL | ORDER CODE |
|-------|------------|
|-------|------------|

| | |
|---------------|----------------|
| V-S53D | Y900176 |
|---------------|----------------|

| MODEL | ORDER CODE |
|-------|------------|
|-------|------------|

| | |
|--------------|----------------|
| V-N50 | Y900182 |
|--------------|----------------|

| MODEL | ORDER CODE |
|-------|------------|
|-------|------------|



| | |
|--------------|----------------|
| V-N51 | Y900183 |
|--------------|----------------|

Each pack of E11, E12 or V30 includes 1 x E Tip replacement wrench. Replacement wrench is not included when ordering other tips. Please order the replacement wrench separately in this instance.

Restorative (For Minimal Intervention)





V-Tip Holder

| MODEL | ORDER CODE |
|------------|----------------|
| V30 | Z217030 |

- Tip is optional



ø0.97

| MODEL | ORDER CODE |
|--------------|----------------|
| V-G70 | Y900118 |

- Diamond coated • Pack of 3



ø1.4

| MODEL | ORDER CODE |
|--------------|----------------|
| V-G71 | Y900119 |

- Diamond coated • Pack of 3



ø1.6

| MODEL | ORDER CODE |
|--------------|----------------|
| V-G72 | Y900120 |

- Diamond coated • Pack of 3

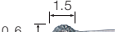

0.6

| MODEL | ORDER CODE |
|--------------|----------------|
| V-G75 | Y900121 |

- Diamond coated • Pack of 3

0.9

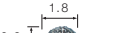



| MODEL | ORDER CODE |
|--------------|----------------|
| V-G76 | Y900122 |



- Diamond coated • Pack of 3

Each pack of E11, E12 or V30 includes 1 x E Tip replacement wrench. Replacement wrench is not included when ordering other tips. Please order the replacement wrench separately in this instance.

Restorative (For Finishing / Trimming / Polishing)





V-Tip Holder

| MODEL | ORDER CODE |
|------------|----------------|
| V30 | Z217030 |

- Tip is optional

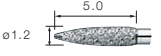

ø1.2

| MODEL | ORDER CODE |
|--------------|----------------|
| V-G77 | Y900165 |

- Diamond coated
- Normal Grade • Pack of 3



ø1.2

| MODEL | ORDER CODE |
|--------------|----------------|
| V-G78 | Y900166 |

- Diamond coated
- Fine Grade • Pack of 3

ø1.2



| MODEL | ORDER CODE |
|--------------|----------------|
| V-G79 | Y900167 |

- Diamond coated
- Super Fine Grade • Pack of 3

Restorative (For Caries Removal)





V-Tip Holder

| MODEL | ORDER CODE |
|------------|----------------|
| V30 | Z217030 |

- Tip is optional

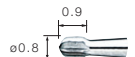

ø0.8

| MODEL | ORDER CODE |
|-------------|----------------|
| V-S1 | Y900161 |

- Stainless Tip • Pack of 3



ø1.1

| MODEL | ORDER CODE |
|-------------|----------------|
| V-S3 | Y900162 |

- Stainless Tip • Pack of 3

ø0.8

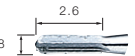
| MODEL | ORDER CODE |
|--------------|----------------|
| V-S33 | Y900163 |

- Stainless Tip • Pack of 3

Tip Kits

Application PERIO



| MODEL | ORDER CODE |
|---------------------------------|----------------|
| NSK Satelec® Perio Kit A | Y900144 |

Contents

- P1D, P2D, P3D, P10 : 1 pc. each
- Tip holder : 1 pc.

Application PERIO

Furcation and curved root face



| MODEL | ORDER CODE |
|---------------------------------|----------------|
| NSK Satelec® Perio Kit B | Y900145 |

Contents

- P20, P25R, P25L : 1 pc. each
- Tip holder : 1 pc.

Application MAINTENANCE

For Prostheses or Implant Maintenance



| MODEL | ORDER CODE |
|--|-----------------|
| NSK Satelec® Perio-Control Tips Starter Kit | Y1002606 |

Contents

- V10 holder : 1 pc.
- V-P11R, V-P11L, V-P12, V-P26R, V-P26L : 1 pc. each
- E Tip replacement wrench : 1 pc.

Application ENDODONTICS

For anterior root canal irrigation



Includes 5 types of U files (ø0.8 mm) plus 120° angle holder

| MODEL | ORDER CODE |
|----------------------------------|----------------|
| NSK Satelec® Endo Kit E11 | Y900146 |

Contents

- E11 : 1 pc. 120° angle holder for anterior teeth
- E Tip replacement wrench : 1 pc.
- U files 33 mm #15, #20, #25, #30, #35 : Pack of 6 each size

Tip Kits

Application ENDODONTICS

For posterior root canal irrigation



Includes 5 types of U files (ø0.8 mm) plus 95° angle holder

| MODEL | ORDER CODE |
|----------------------------------|----------------|
| NSK Satelec® Endo Kit E12 | Y900147 |

Contents

- E12 : 1 pc. 95° angle holder for posterior teeth
- E Tip replacement wrench : 1 pc.
- U files 33 mm #15, #20, #25, #30, #35 : Pack of 6 each size

Application ENDODONTICS

4 kinds of Retrograde Root filling tips



| MODEL | ORDER CODE |
|-------------------------------|----------------|
| NSK Satelec® Retro Kit | Y900149 |

Contents

- E30RD, E30LD, E31D, E32D : 1 pc. each
- Tip holder : 1 pc.

Application MINIMAL INTERVENTION

Starter kit for Minimal Intervention - with V-Tip holder



| MODEL | ORDER CODE |
|------------------------------------|----------------|
| NSK Satelec® MI Starter Kit | Y900150 |

Contents

- V30 V-tip holder : 1 pc.
- E tip replacement wrench : 1 pc.
- V-G70, V-G71, V-G72 : 1 pc. each
- V-S1, V-S3, V-S33 : 1 pc. each
- V-G77, V-G78, V-G79 : 1 pc. each

Ti-Max S970



Air Scaler Evolution Supporting a Broad Spectrum of Care

The S970 air scaler offers a wide power range with easy swivel power adjustment and an extensive tip range for a wide variety of applications ranging from general scaling and root canal irrigation to minimally invasive procedures. The wide range of applications, comfortable grip and ease of maintenance makes the S970 air scaler the instrument of choice for dentists and hygienists alike.

A titanium body and sleek, seamless design make the S970 really comfortable to hold even during long procedures whilst allowing for excellent visibility of the operating site at all times.

Steady Power Supply to The Tip

S970 air scalers provide stable power output and constant oscillating movement across the entire power range at approximately 6,000 Hz. S970 air scalers are extremely gentle and therefore very popular in cases involving perio or high sensitivity.

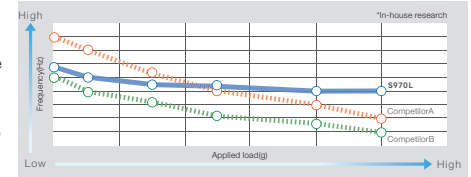

Excellent Visibility

The sleek design of the S970 allows for unrestricted visibility of the treatment area and excellent access to even the most hard to reach areas.

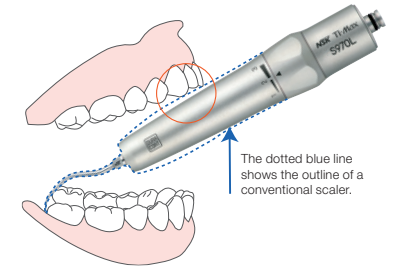

The dotted blue line shows the outline of a conventional scaler.

Smooth and Easy Power Control Ring

NSK Power Ring offers three different power level settings for diverse clinical needs. While the gentle minimum mode is for delicate procedures, the maximum power mode is good for general scaling.



| APPLICATIONS | TIPS | POWER RING SETTING | | |
|--|--|--------------------|---|---|
| | | 1 | 2 | 3 |
| Scaling | S1, S2, S3 | ←→→→ | | |
| Perio | S10, S20, S21R, S21L | ←→→ | | |
| Perio (Maintenance Tip) | S35+V-Tip (V-P10, V-P11R, V-P11L, V-P12) | ←→→ | | |
| Restorative (For Preparation of crown cores) | S81D, S82D, S83D, S86D, S71D, S72D | ←→→ | | |
| Restorative (For Minimal Intervention) | S65D, S66D, S67D, S68D | ←→→ | | |
| V-TIP SYSTEM (Endodontics) | S75+V-Tip (V-U15-V-U35) | ←→ | | |

The above power level is standard. Please start using from a low level to correspond to the symptoms.

Ti-Max S970



- Titanium Body with Scratch Resistant DURACOAT
- 3 level Power Ring
- Frequency of oscillation : 5,800-6,200 Hz
- Cellular Glass Optics



Includes 3 tips (S1, S2 & S3),
Tip Wrench (CR-20) and
Tip Cover (L)

Connect to NSK Couplings

| Optic | MODEL | ORDER CODE |
|-------|--------------|--------------|
| ● | S970L | T1005 |
| — | S970 | T1020 |

Connect Direct to KaVo® Coupling

| Optic | MODEL | ORDER CODE |
|-------|---------------|--------------|
| ● | S970KL | T1013 |

Connect Direct to Sirona® Coupling

| Optic | MODEL | ORDER CODE |
|-------|---------------|--------------|
| ● | S970SL | T1015 |

AS2000

- Frequency of oscillation : 5,600-6,000 Hz
- Includes 3 tips (S1, S2 & S3), Tip Wrench (CR-20) and Tip Cover (L)



| Optic | MODEL | ORDER CODE |
|-------|------------------|-------------|
| — | AS2000 M4 | T698 |

- For Midwest 4 hole • Weight : 67 g



| Optic | MODEL | ORDER CODE |
|-------|-----------------------|-------------|
| — | AS2000 B2 / B3 | T697 |

- For Borden 2/3 hole • Weight : 64 g

Air Scaler Tips

Scaling

Cross Section Diagram



| MODEL | ORDER CODE |
|-----------|----------------|
| S1 | Z252411 |

S1 **Z252411**

- Universal Type



| MODEL | ORDER CODE |
|-----------|----------------|
| S2 | Z252413 |

S2 **Z252413**

- Sickle Type



| MODEL | ORDER CODE |
|-----------|----------------|
| S3 | Z252412 |

S3 **Z252412**

- Perio Type

Perio

Cross Section Diagram



| MODEL | ORDER CODE |
|------------|----------------|
| S10 | Z252420 |

S10 **Z252420**

- Universal Type Slim Line



| MODEL | ORDER CODE |
|------------|----------------|
| S20 | Z252441 |

S20 **Z252441**

- Root Planning (Straight tip)



| MODEL | ORDER CODE |
|-------------|----------------|
| S21R | Z252442 |

S21R **Z252442**

- Root Planning (Right curved tip)



| MODEL | ORDER CODE |
|-------------|----------------|
| S21L | Z252443 |

S21L **Z252443**

- Root Planning (Left curved tip)

Maintenance (V-Tip)



V-Tip Holder



Cross Section Diagram



| MODEL | ORDER CODE |
|------------|----------------|
| S35 | Z252015 |

S35 **Z252015**

- Includes E-Tip replacement wrench
- Plastic Tip is not included



| MODEL | ORDER CODE |
|--------------|----------------|
| V-P10 | Y900184 |

V-P10 **Y900184**

- Pack of 3
- S35 holder is not included



| MODEL | ORDER CODE |
|--------------|-----------------|
| V-P12 | Y1002167 |

V-P12 **Y1002167**

- Pack of 3
- S35 holder is not included



| MODEL | ORDER CODE |
|---------------|-----------------|
| V-P11R | Y1002165 |

V-P11R **Y1002165**

- Right curved type
- Pack of 3
- S35 holder is not included

| MODEL | ORDER CODE |
|---------------|-----------------|
| V-P11L | Y1002166 |

V-P11L **Y1002166**

- Left curved type
- Pack of 3
- S35 holder is not included

Air Scaler Kit



| MODEL | ORDER CODE |
|---|------------|
| Perio-Control Tips Air Scaler Kit Y1002754 | |

Perio-Control Tips Air Scaler Kit Y1002754

- S35 holder : 1 pc.
- V-P10, V-P11R, V-P11L, V-P12 : 1 pc. each
- Includes E-Tip replacement wrench

Restorative (For Minimal Intervention)

Unlike rotary instruments these tips oscillate and are designed to only cut on one surface allowing minimally invasive site preparation and thereby greatly reducing the risk of damaging adjacent teeth and soft tissue. The spherical shape of these tips make them suitable for delicate adjustments as well as caries removal in the cervical and interproximal region.



| MODEL | ORDER CODE |
|-------------|----------------|
| S65D | Z252465 |

• Diamond coated



| MODEL | ORDER CODE |
|-------------|----------------|
| S66D | Z252466 |

• Diamond coated



| MODEL | ORDER CODE |
|-------------|----------------|
| S67D | Z252467 |

• Diamond coated



| MODEL | ORDER CODE |
|-------------|----------------|
| S68D | Z252468 |

• Diamond coated

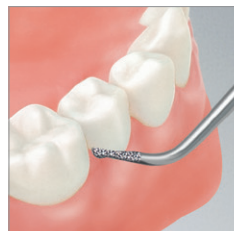

S65D

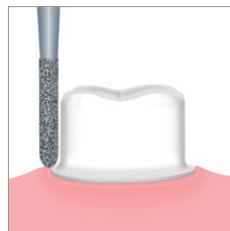

S81D

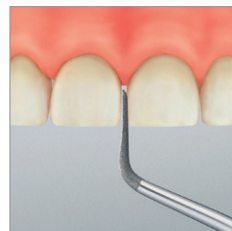

S72D

Restorative (For Preparation of Crown Cores)

The tips can be used for finishing margins after prepping the area with a conventional dental bur. That enables you to finish minute sharp edges and gingival sulcus without damage, something that cannot be accomplished with rotary instruments alone. Three types of tips are available for deep chamfer, light chamfer and shoulder work, respectively.



| MODEL | ORDER CODE |
|-------------|----------------|
| S81D | Z252469 |

• Diamond coated



| MODEL | ORDER CODE |
|-------------|----------------|
| S82D | Z252462 |

• Diamond coated



| MODEL | ORDER CODE |
|-------------|----------------|
| S83D | Z252461 |

• Diamond coated



| MODEL | ORDER CODE |
|-------------|----------------|
| S86D | Z252460 |

• Diamond coated

These tips are safe sided and flat for minimal mesial or distal preparations.



| MODEL | ORDER CODE |
|-------------|----------------|
| S71D | Z252471 |

• Diamond coated



| MODEL | ORDER CODE |
|-------------|----------------|
| S72D | Z252472 |

• Diamond coated

V-TIP System



NSK V-Tip system is innovative, multi-functional and economical. The V-Tip holder is a separate component to the actual cutting tips and can be easily and inexpensively replaced. NSK V-Tip holder system offers the flexibility and expandability to meet the wide requirements for multi-purpose clinical applications.

Endodontics V-Tip



Endodontics P.157

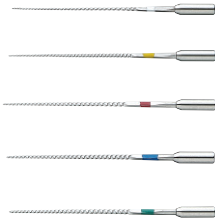

S75
120° Angle type

Maintenance P.153

- For Protheses or Implant Maintenance Perio-Control



S35
Straight

| MODEL | ORDER CODE |
|-------|------------|
|-------|------------|

S75 **Z252035**

- Includes E-Tip replacement wrench

| MODEL | ORDER CODE |
|-------|------------|
|-------|------------|

V-U15 **Y900177**

- V-file Irrigation 23 mm #15
- ISO 15 • Pack of 6

| MODEL | ORDER CODE |
|-------|------------|
|-------|------------|

V-U20 **Y900178**

- V-file Irrigation 23 mm #20
- ISO 20 • Pack of 6

| MODEL | ORDER CODE |
|-------|------------|
|-------|------------|

V-U25 **Y900179**

- V-file Irrigation 23 mm #25
- ISO 25 • Pack of 6

| MODEL | ORDER CODE |
|-------|------------|
|-------|------------|

V-U30 **Y900180**

- V-file Irrigation 23 mm #30
- ISO 30 • Pack of 6

| MODEL | ORDER CODE |
|-------|------------|
|-------|------------|

V-U35 **Y900181**

- V-file Irrigation 23 mm #35
- ISO 35 • Pack of 6

iProphy

Put control back in your hands



Lightweight and easy to hold.

Designed and developed to include the latest ergonomic features. The lightweight, easy to hold and well-balanced handpiece feels light in the hand even when used for a long time.

An ultra mini head guarantees the best possible field of vision.

The thin, long ultra mini head ensures a wide field of vision within the oral cavity, easy access and excellent reach. Facilitates even smoother and more precise treatment.



Simple operating controls.

Control at your fingertips (no foot-control required). iProphy easily maintains low speed rotation, which can be difficult with conventional contra-angles.

Simple and clean user interface.

Allowing procedures to be stress-free. Also has a large and easy to operate ON/OFF key.



iProphy Complete Set

| MODEL | ORDER CODE |
|-----------------------------|-----------------|
| iProphy Complete set | Y1500015 |

Contents :

- iProphy Motor handpiece
- iFX57 Head
- iProphy Stand
- AC ADAPTOR
- F-Type Spray Nozzle

iProphy without Head

| MODEL | ORDER CODE |
|--------------------|-----------------|
| iProphy W/O | Y1500069 |

Contents :

- iProphy Motor handpiece
- iProphy Stand
- AC ADAPTOR
- F-Type Spray Nozzle

iProphy Heads



- For Prophy
- For screw-in type

- For disposable prophy angle

| | MODEL | ORDER CODE |
|----------------------|--------------|--------------|
| Reduction 4:1 | iFX57 | C1102 |
| Reduction 4:1 | PR-F | H209 |